

EASYDRAIN™ | EASYDRAIN™ COMPACT | FLO-WAY™ | RAINWATER



EVERHARD
SURFACE WATER DRAINAGE

A fully integrated surface water drainage solution for your home

SELECTING THE SYSTEM THAT'S RIGHT FOR YOU

EasyDRAIN™ COMPACT

EasyDRAIN™

Flo-way™ / Rainwater

HANDY HINT

For swimming pools we recommend polymer or EURODESIGN 316 stainless steel grates

Our fully integrated surface water drainage system is light-weight with click-together technology and moulded outlets to make installation quick and easy. Our products are injection moulded right here in Australia and are made from tough, recycled, UV stabilised polymer.

When you see this colour on our products, you know it's EasyDRAIN™ COMPACT!

When you see this colour on our products, you know it's EasyDRAIN™!

When you see this colour on our products, you know it's Flo-way™ / Rainwater!

APPLICATION GUIDE

AREA

- Exterior patios
- Paved terraces
- Car parks
- Driveways
- Walkways
- Playgrounds
- Swimming pools

WATER FLOW

LOW MEDIUM HIGH

The number of connecting pipes can affect water flow. Refer to page 13 for tips on water flow.

RAINFALL

For swimming pools we recommend polymer or EURODESIGN 316 stainless steel grates. Galvanised grates are not suitable for swimming pools or environments affected by salt water

EasyDRAIN™ COMPACT

- 80mm profile makes for easy installation and is suitable for areas with low rainfall and water flow
- Available in 3m pre-joined lengths for larger areas
- Comes complete with heel-friendly grates. Available in black polymer or galvanised steel
- Ideal for small outdoor areas and around swimming pools

EasyDRAIN™

- 100mm profile is suitable for high rainwater levels and water flow
- Available in 3m pre-joined lengths for larger areas
- Comes complete with a range of galvanised steel, stainless steel and polymer grate options - See Grate Guide for complete list
- Ideal for driveways, gardens and large outdoor areas

GRATE GUIDE

MATERIAL	CHANNEL	CORNER	TEE	SLIM PIT
BLACK AND COLOUR POLYMER	<ul style="list-style-type: none"> Suitable across domestic driveways, around swimming pools and areas affected by salt Available in Black, Terracotta and Sandstone Proudly Australian made and owned Made from recycled materials Fits EasyDRAIN™ Channel 			
HEEL FRIENDLY BLACK POLYMER	<ul style="list-style-type: none"> Heel friendly pattern suitable for pedestrian areas and pathways Suitable across domestic driveways, around swimming pools and areas affected by salt Proudly Australian made and owned Made from recycled materials Fits EasyDRAIN™ Compact Channel 			
PRESSED GALVANISED STEEL	<ul style="list-style-type: none"> Heel friendly pattern suitable for pedestrian areas and pathways Not suitable around swimming pools or areas affected by salt Flat upper surface of metal grates may show signs of slight indentation over time if used in a driveway Fits EasyDRAIN™ and Compact Channel 			
PRESSED STAINLESS STEEL	<ul style="list-style-type: none"> Not suitable around swimming pools or areas affected by salt Flat upper surface of metal grates may show signs of slight indentation over time if used in a driveway Fits EasyDRAIN™ Channel 			
EURODESIGN™ 316 STAINLESS STEEL	<ul style="list-style-type: none"> Heel friendly pattern suitable for pedestrian areas and pathways Not suitable for driveways Suitable around swimming pools and areas affected by salt Proudly Australian made and owned Fits EasyDRAIN™ Channel 			
GALVANISED ROUND BAR	<ul style="list-style-type: none"> Heel friendly pattern suitable for pedestrian areas and pathways Not suitable around swimming pools or environments affected by salt water Suitable across domestic driveways Fits EasyDRAIN™ Channel 			

All variations of Channel and Grate are sold as complete unit. Grates not sold separately

THE COMPLETE
SURFACE WATER DRAINAGE SYSTEM

EasyDRAIN™ is a fully integrated surface water drainage solution for your home, available in 100mm or 80mm profile



- ✓ EasyDRAIN™ comes complete with various grate options
- ✓ 1 metre lengths easily join together and with other components by simply clicking together
- ✓ Black polymer grate and channel made from tough, recycled UV stabilised polymer
- ✓ Comes in 100mm profile to capture larger volume of water flow or 80mm profile for easy installation
- ✓ 200mm paver-length segments moulded into channel allows for easy cutting and rejoining with use of a converter
- ✓ Connects to 75mm, 90mm and 100mm pvc pipe
- ✓ Anti-flotation design eliminates the need for reinforcement
- ✓ Polymer is ideal for swimming pools and coastal areas affected by salt water and is 100% Australian Made

Visit everhard.com.au/install to view the EasyDRAIN™ installation video



NEW
Now offering the complete Compact Drainage System Range

Pictured: 83500

A GUIDE TO EasyDRAIN™ COMPACT

Specifications, Features and Benefits

Our EasyDRAIN™ COMPACT system is the only complete system in the market with a shallow 80mm profile, making it ideal for low rainfall and low water flow areas

COMPACT CHANNEL & GRATE
Available in 1m and 3m lengths. Collects and distributes water away from areas around the home

- Comes standard with heel friendly grate options in black polymer and galvanised steel
- Comes in 1 metre and 3 metre lengths that easily join together and with other components by simply clicking together
- Black polymer grate and channel made from tough, recycled UV stabilised polymer - ideal around swimming pools and in coastal areas

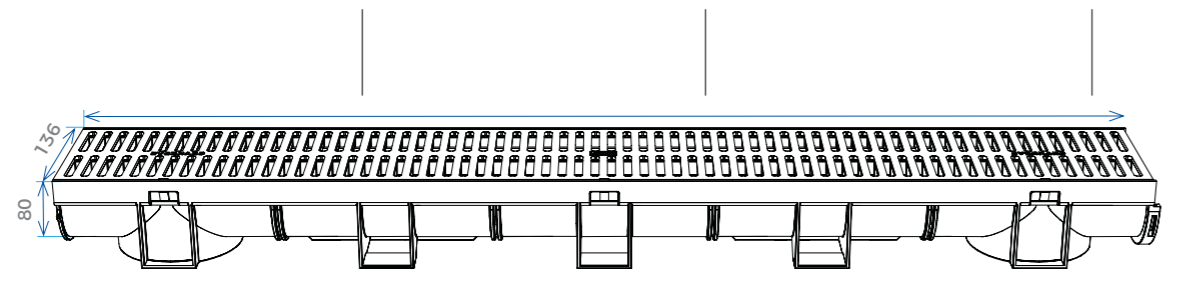

- Shallow 80mm profile allows for quick installation - ideal for low rainfall areas
- 200mm paver-length segments moulded into channel, allowing for easy cutting and rejoining with converter
- Connects to 75mm, 90mm and 100mm pvc pipe

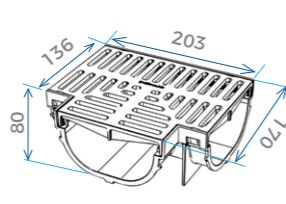
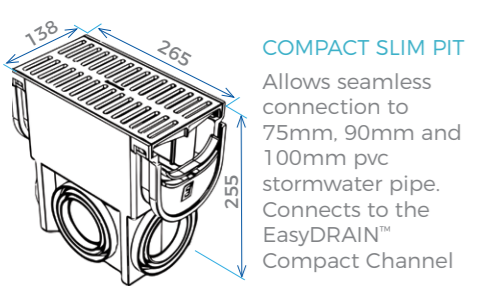

COMPACT TEE PIECE
Allows for an easy change of direction. Connects to the EasyDRAIN™ Compact Channel

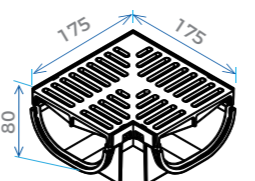

COMPACT CORNER
Allows for an easy change of direction. Connects to the EasyDRAIN™ Compact Channel

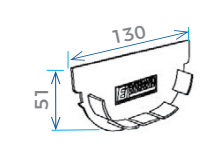

COMPACT END CAP
Provides a finishing point at the end of the EasyDRAIN™ Compact Channel

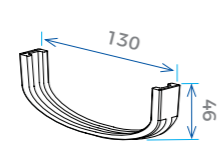

COMPACT CONVERTER
Acts as a joiner between cut ends of EasyDRAIN™ Compact Channel by converting a male end into a female end

HANDY HINT
Galvanised grates are not suitable around swimming pools or environments affected by salt water

Note: All measurements are in millimeters. Dimensions may vary due to the nature of polymer

NEW

EasyDRAIN™ Compact Black Polymer Slim Pit with Black Polymer Grate
Product code: 83540
Weight (kg): 1.07

Also available with Pressed Galvanised Steel Grate | Product Code: 83540G

NEW

EasyDRAIN™ Compact Black Polymer Tee Piece with Black Polymer Grate
Product code: 83550
Weight (kg): 0.32

Also available with Pressed Galvanised Steel Grate | Product Code: 83550G

EasyDRAIN™ Compact Black Polymer Channel with Black Polymer Grate - 1 metre + 3 metre
Product codes: 1M 83500 | 3M 83530
Weight (kg): 1M 1.70 | 3M 5.05

1M also available with Pressed Galvanised Steel Grate | Product Code: 83501

EasyDRAIN™ Compact Black Polymer Corner with Black Polymer Grate
Product code: 83600
Weight (kg): 0.31

Also available with Pressed Galvanised Steel Grate | Product Code: 83601

EasyDRAIN™ Compact Black Polymer End Cap for Channel and Grate
Product code: 83700
Weight (kg): 0.03

EasyDRAIN™ Compact Black Polymer Converter for Channel and Grate
Product code: 83701
Weight (kg): 0.01

Refer to Page 3 for Pressed Galvanised Steel grate. Refer to page 14 for all product and grate variations

NEW

Our EasyDRAIN™ Leaf Dome fits both the EasyDRAIN™ Range and the EasyDRAIN™ Compact Range. See next page for details.



HANDY HINT
 You'll need a converter to connect two male channel ends together or connect a corner to a male end of channel

Pictured: 83300



A GUIDE TO EasyDRAIN™

Specifications, Features and Benefits

Our EasyDRAIN™ channel and grate system provides everything you need to create an effective, fully integrated surface water drainage system. We offer a range of accessories and materials to suit any DIY project

CHANNEL & GRATE

Available in 1m and 3m lengths. Collects and distributes water away from areas around the home

- Comes standard with a range of grate options in Polymer, Galvanised Steel and Stainless Steel
- Comes in 1 metre and 3 metre lengths. Easily join together and with other components by simply clicking together
- 100mm profile to capture larger volume of water flow - ideal for heavy rainfall areas

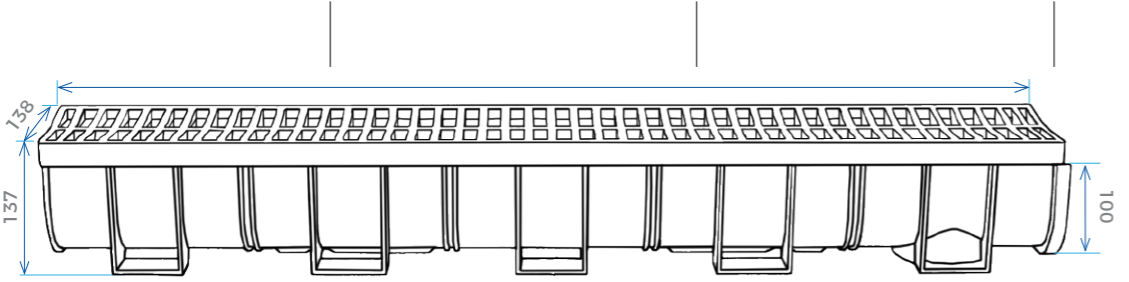

- 200mm paver-length segments moulded into channel, allowing for easy cutting and rejoining with converter
- Black polymer channel and grate made from tough, recycled UV stabilised polymer - ideal for driveways and large outdoor areas
- Connects to 75mm, 90mm and 100mm pvc pipe

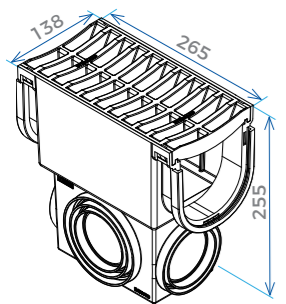

SLIM PIT
 Allows seamless connection to 75mm, 90mm and 100mm pvc stormwater pipe. Connects to the EasyDRAIN™ Channel

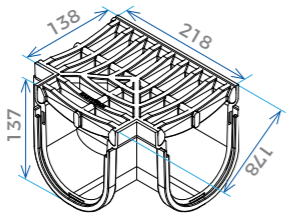

TEE PIECE
 Allows for easy change of direction. Connects to the EasyDRAIN™ Channel

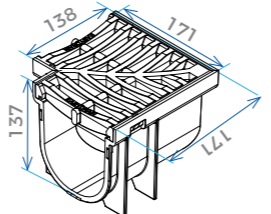

CORNER
 Allows for easy change of direction. Connects to the EasyDRAIN™ Channel

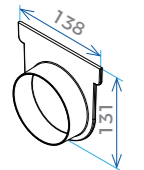

END CAP
 Provides a finishing point at the end of the EasyDRAIN™ Channel. Also allows for stormwater connection at the end of the EasyDRAIN™ Channel

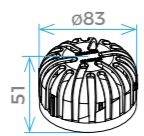

LEAF DOME
 Provides a barrier against leaves and other debris from entering waterways. Suitable for both EasyDRAIN™ and EasyDRAIN™ Compact ranges

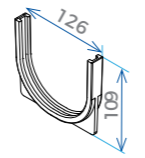

CONVERTER
 Acts as a joiner between cut ends of EasyDRAIN™ channel by converting a male end into a female end

Note: All measurements are in millimeters. Dimensions may vary due to the nature of polymer



EasyDRAIN™ Black Polymer Channel with Black Polymer Grate - 1 metre and 3 metre
 Product codes: 1M 83300 | 3M 83390
 Weight (kg): 1M 2.70 | 3M 7.90

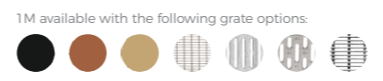

1M and 3M available with a range of grate options. Refer to page 14 for product variations



EasyDRAIN™ Black Polymer Slim Pit with Black Polymer Grate
 Product code: 83800
 Weight (kg): 1.11



Available with a range of grate options. Refer to page 14 for product variations



EasyDRAIN™ Black Polymer Corner with Black Polymer Grate
 Product code: 83330
 Weight (kg): 0.54



Available with a range of grate options. Refer to page 14 for product variations



EasyDRAIN™ Black Polymer Tee Piece with Black Polymer Grate
 Product code: 83400
 Weight (kg): 0.66



Available with a range of grate options. Refer to page 14 for product variations



EasyDRAIN™ Black Polymer End Cap for Channel and Grate
 Product code: 83360
 Weight (kg): 0.06



EasyDRAIN™ Black Polymer Leaf Dome for Channel and Grate
 Product code: 84040
 Weight (kg): 0.02



EasyDRAIN™ Black Polymer Converter for Channel and Grate
 Product code: 83370
 Weight (kg): 0.03



Refer to page 14 for all product and grate variations

For a commercial drainage solution view our range of TechnoDRAIN



TechnoDRAIN is an ideal surface water drainage solution for driveways and parking lots that support areas of vehicle traffic up to Class D
 For more information and to find a stockist visit everhard.com.au



HANDY HINT
Where rainwater pits are connecting to a stormwater pipe, we recommend using a Pit Boss for seamless connection

A GUIDE TO Flo-way™ / Rainwater Pits & Grates

Specifications, Features and Benefits

Our Flo-way™ / Rainwater Pits and Grates are designed to integrate with the EasyDRAIN™ range. It is an innovative and simple approach to solving your drainage problems

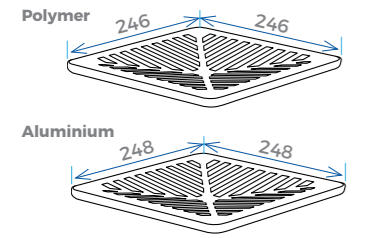

PIT GRATES
Sits on top of a Rainwater Pit or Flo-way™ Pit to allow water to drain into pit. Grates can be purchased complete with Flo-way™ Pit or separately for Rainwater Pit

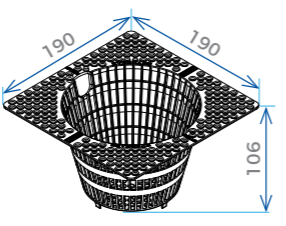

LEAF BASKET
Fits Rainwater Pit and assists flow of surface water by providing a barrier against leaves and other debris entering the waterways

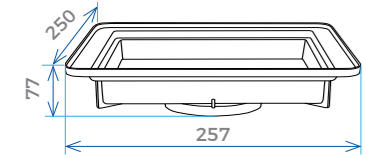

FLO-WAY™ PIT
Square trap design funnels rainwater directly into a connected stormwater pipe. Suits 90mm or 100mm PVC pipe

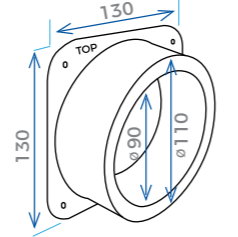

PIT BOSS
Creates a pipe connection to pits, reducing issues caused by subsidence of the ground or improper installation connections. Assists in maintaining the fall of the pipework into the pit

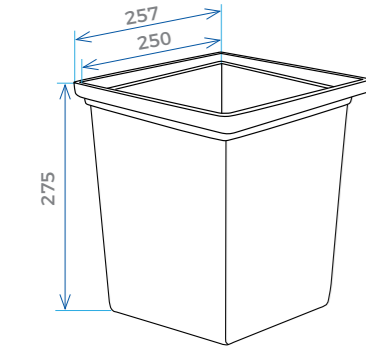

RAINWATER PIT
Designed as a drainage collection point by itself or for connection to the EasyDRAIN™ Channel and Grate system

HANDY HINT
The Pit Boss is angled to meet the angle of the pit being installed, to maintain the fall of the pipework

Note: All measurements are in millimeters. Dimensions may vary due to the nature of polymer



Flo-way™ Shallow with Black Polymer Grate
Product code: 84812
Weight (kg) 0.50



EasyDRAIN™ Rainwater Pit with Black Polymer Grate
Product code: 84767
Weight (kg) 1.10



Pit Boss to suit EasyDRAIN™ Rainwater Pit
Product code: 80080
Weight (kg) 0.60



Leaf Basket to suit EasyDRAIN™ Rainwater Pit
Product code: 84041
Weight (kg) 1.00



Refer to page 15 for all product and grate variations

Features and Benefits

- ✓ The Flo-way™ Pit square trap design funnels rainwater directly into a connected stormwater pipe
- ✓ Flo-way™ Pits come complete with grate, available in a range of colours
- ✓ Rainwater Pits are designed as a drainage collection point by itself or for connection to the EasyDRAIN™ Channel and Grate System
- ✓ Rainwater Pits and Grates come separately or complete with black polymer or aluminium grate
- ✓ Easy to install into any domestic or non trafficable application
- ✓ Suits 90mm or 100mm PVC Pipe
- ✓ Made from UV stabilised polymer material
- ✓ Black polymer is made from 100% recycled plastic
- ✓ 100% Australian made

Flo-way™ Grates

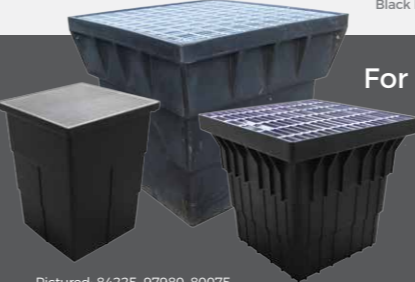
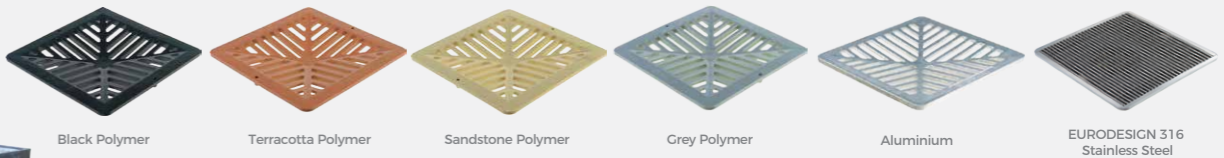

For a commercial stormwater solution view our range of Stormwater Pits and Grates

- ✓ Made from durable, UV resistant polypropylene
- ✓ Ideal for trafficable areas
- ✓ Easy to handle and install
- ✓ Comply with Australian Standards
- ✓ Come with a range of grates
- ✓ Pits are 100% Australian Made

For more information and to find a stockist visit everhard.com.au

Pictured: 84225, 97980, 80075

CONNECTION INSTRUCTIONS

HOW EASYDRAIN™ CONNECTS TOGETHER

EasyDRAIN™ uses a click-together male to female interlocking system. To prevent seepage at joints, use a suitable silicon.

Cutting and Connecting Channel and Grate:

- Remove grate from channel and flip channel over
- Use a saw to cut between the ribs that are 200mm from the female end. Refer to Figure 1
- Trim the ends with a utility knife so that the ribs are neat and all excess plastic is removed
- Place grate back into cut channel and mark the cut area ensuring the grate is positioned correctly in channel
- Remove grate and cut using a cutting disk for a neat edge
- Connect the male and female ends together by pushing the male end down into the female end until it 'clicks' into place

Figure 1

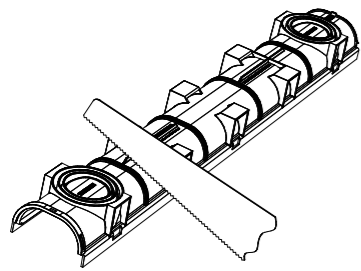

Connecting Converter:

Use the Converter when connecting two male ends together or to convert a male end to a female end of channel.

- Flip both lengths of channel over and position ends together
- Click converter into place and seal with silicone

Connecting Slim Pit:

Use a Slim Pit to connect EasyDRAIN™ to a stormwater pipe located at a side angle to drainage.

- Slim Pit has all female ends so you will need to ensure you connect to a male end of channel

* Refer to compact variations for Compact Slim Pit

Connecting Corner and Tee:

Use the Corner and Tee to change direction of your channel.

- Corner Piece has all male ends so you will need to use a converter when connecting to a male end of channel

- Tee Piece has all female ends so you will need to ensure you connect to a male end of the channel

- Tee Piece and Corner Piece will connect to each other without the need for a converter

* Refer to compact variations for Compact Tee and Corner

Connecting End Cap:

Use an End Cap to create an end point for your drainage system and seal with silicone.

- You can also use an End Cap to connect to a stormwater pipe and / or leaf dome by cutting out the required sized hole
- Connect your End Cap to a female end of channel or a male end using a converter

Connecting Leaf Dome:

Use a Leaf Dome to prevent leaves and other debris from entering the stormwater system.

- Install Leaf Dome at the entry point of your stormwater outlet in the bottom of your channel, Slim Pit or at the end of the channel using an End Cap
- Cut the required sized hole in the centre of the outlet inside of the circular moulded edge and seal using silicone

COMPACT VARIATIONS

Connecting Compact Slim Pit:

- When connecting Compact Channel to a Compact Slim Pit, first trim the locking tabs off each side of the male end of channel. Refer to Figure 2

NOTE: If you have cut the channel to size there will be no locking tabs present on the channel

- Locate the lever of the connector at the opening of the Compact Slim Pit and pull upwards towards the grate until it clicks out of place. Refer to Figure 3

- Position the male end of the channel into the top of the connector so the lip of the channel slots into the ribs of the lever and push down until it clicks back into place. Refer to Figure 4

Figure 2

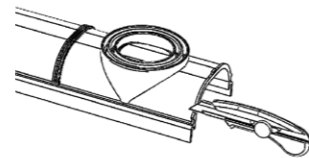

Figure 3

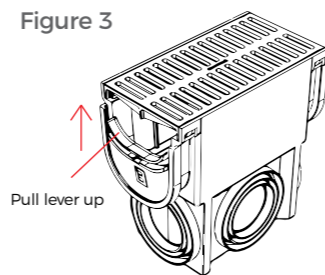
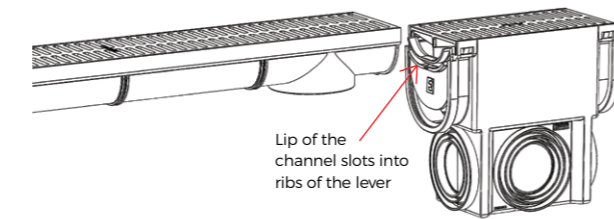

Figure 4



Connecting Compact Corner:

- Compact Corner Piece has all female ends so you will need to ensure you connect to a male end of channel

NOTE: You cannot connect a Compact Corner directly to a Compact Slim Pit. You will need to use a section of cut channel between a Compact Corner and Compact Slim Pit, ensuring you have a male end for connection to the Compact Slim Pit

Connecting Compact Tee:

- Compact Tee has all male ends so you will need to use a Compact Converter when connecting to a male end of channel

- Compact Tee will connect directly into a Compact Slim Pit, a Compact Corner or female end of channel

INSTALLATION INSTRUCTIONS

1.

PREPARE

- ✓ Dig your trench 50mm deeper and wider than the channel being installed and not less than 75mm wider than the width of the channel at its lip
- ✓ Slope the trench at a ratio of 1cm for every 1m of channel
- ✓ Pour concrete slurry in the base of the trench
- ✓ Use a string line to ensure straightness and the correct finish height

2.

INSTALL

- ✓ Grates must be locked into channel prior to installation and it is recommended that you connect sections together before placing in trench
- ✓ Connect your EasyDRAIN™ Channel and Grate with other elements to complete your drainage system, ensuring to connect End Cap to the highest point of your channel
- ✓ To connect to a PVC pipe, cut a hole in the base of the Channel, Slim Pit or End Cap as required, guided by the outlet collar and seal with silicone
- ✓ Place drainage into trench and push the channel into the concrete slurry so the feet of the channel are completely immersed

3.

FINISH

- ✓ Place suitable expansion material such as a closed cell foam along the top edge of the channel running the entire length of channel, approximately 75mm wide and 10mm thick, then attach to channel with adhesive tape. This will assist with the removal of the grate when required
- ✓ Pour concrete down each side of the channel, ensuring the base is completely immersed
- ✓ Lightly compact and finish the concrete approximately 2-3mm above the surface level of the grate to promote run off from surrounding area into drain

INSTALLATION TIPS



WATER FLOW

When determining water flow you will need to consider the following variables that may increase the volume of water flowing into your drainage system: the type of soil; the slope of the land; the size of the stormwater pipes; and the number of stormwater pipe connections.



REMOVING GRATES

For cleaning and maintenance purposes, grates can only be removed if they have been installed using a suitable expansion material. To remove grate, place the tip of a screw-driver into the flange, where the grate and channel connect. Gently push the edge of the channel outwards until the grate pops out. Repeat this for each flange along the channel.



PRE-EXISTING CONCRETE

If installing EasyDRAIN™ against pre-existing concrete or pavers, it is recommended that you 1. Dig your trench with enough room for drainage plus an additional 15-20mm below surface level 2. Pour concrete into the base of the trench and place in EasyDRAIN™ Channel and Grate 3. Push the channel and grate down into the concrete, allowing for excess concrete to push up the side of the channel away from the existing concrete.



TRAFFICABLE AREAS

If you are installing your EasyDRAIN™ system in an area that may receive some vehicle traffic such as a driveway, you will need to ensure that you install your channel in concrete. For driveways, we recommend our range of polymer grates. Refer to installation instructions above.

PLEASE NOTE: All EasyDRAIN™ Grates are Class A only. For drainage systems that support up to Class D traffic, view our TechnoDRAIN range at everhard.com.au

PRODUCT VARIATION INFORMATION

EasyDRAIN™ Compact

Product Description	EI Code	Length	Width	Height
Black Polymer 1M Channel with Pressed Galvanised Steel Grate	83501	1000mm	136mm	80mm
Black Polymer Corner with Pressed Galvanised Steel Grate	83601	175mm	175mm	80mm
Black Polymer Tee with Pressed Galvanised Steel Grate	83550G	203mm	170mm	80mm
Black Polymer Slim Pit with Pressed Galvanised Steel Grate	83540G	265mm	138mm	255mm

EasyDRAIN™

Product Description	EI Code	Length	Width	Height
Black Polymer 1M Channel with Black Polymer Grate x 3 Pack	83387	1000mm	138mm	137mm
Black Polymer 1M Channel with Sandstone Polymer Grate	83300S	1000mm	138mm	137mm
Black Polymer Corner with Sandstone Polymer Grate	83330S	171mm	171mm	137mm
Black Polymer Tee with Sandstone Polymer Grate	83400S	218mm	178mm	137mm
Black Polymer 1M Channel with Terracotta Polymer Grate	83300T	1000mm	138mm	137mm
Black Polymer Corner with Terracotta Polymer Grate	83330T	171mm	171mm	137mm
Black Polymer Tee with Terracotta Polymer Grate	83400T	218mm	178mm	137mm
Black Polymer 1M Channel with Pressed Galvanised Steel Grate	83432	1000mm	138mm	137mm
Black Polymer 3M Channel with Pressed Galvanised Steel Grate	83433	3000mm	138mm	137mm
Black Polymer Corner with Pressed Galvanised Steel Grate	83338	171mm	171mm	137mm
Black Polymer Tee with Pressed Galvanised Steel Grate	83900	218mm	178mm	137mm
Black Polymer Slim Pit with Pressed Galvanised Steel Grate	83802	265mm	138mm	255mm
Black Polymer 1M Channel with Pressed Stainless Steel Grate	83303	1000mm	138mm	137mm
Black Polymer 3M Channel with Pressed Stainless Steel Grate	83393	3000mm	138mm	137mm
Black Polymer Corner with Pressed Stainless Steel Grate	83333	171mm	171mm	137mm
Black Polymer Tee with Pressed Stainless Steel Grate	83901	218mm	178mm	137mm
Black Polymer Slim Pit with Pressed Stainless Steel Grate	83801	265mm	138mm	255mm
Black Polymer 1M Channel with Galvanised Round Bar Grate	83307	1000mm	138mm	137mm
Black Polymer 3M Channel with Galvanised Round Bar Grate	83395	3000mm	138mm	137mm
Black Polymer 1M Channel with EURODESIGN Stainless Steel Grate	83308	1000mm	138mm	137mm
Black Polymer 1M Channel with EURODESIGN Stainless Steel A/V Grate	83309	1000mm	138mm	137mm
Black Polymer Corner with EURODESIGN Stainless Steel Grate	83335	171mm	171mm	137mm
Black Polymer Tee with EURODESIGN Stainless Steel Grate	83403	218mm	178mm	137mm
Black Polymer Slim Pit with EURODESIGN Stainless Steel Grate	83803	265mm	138mm	255mm

PRODUCT VARIATION INFORMATION

EasyDRAIN™ Flo-way™ / Rainwater Pits & Grates

Product Description	EI Code	Length	Width	Depth
Flo-way™ Shallow with Terracotta Polymer Grate	84757	257mm	257mm	77mm
Flo-way™ Shallow with Sandstone Polymer Grate	84774	257mm	257mm	77mm
Flo-way™ Shallow with Grey Polymer Grate	84756	257mm	257mm	77mm
Flo-way™ Shallow with Aluminium Polymer Grate	84762	257mm	257mm	77mm
Flo-way™ Shallow with EURODESIGN Stainless Steel Grate	84744	257mm	257mm	77mm
Flo-way™ Shallow with EURODESIGN Stainless Steel A/V Grate	84745	257mm	257mm	77mm
Rainwater Pit Case Only	84825	257mm	257mm	275mm
Rainwater Pit with Aluminium Grate	84768	257mm	257mm	275mm
Rainwater Pit with EURODESIGN Stainless Steel Grate	84777	257mm	257mm	275mm
Rainwater Pit with EURODESIGN Stainless Steel A/V Grate	84778	257mm	257mm	275mm
Flo-way™ / Rainwater Black Polymer Grate Only	81010	246mm	246mm	20mm
Flo-way™ / Rainwater Terracotta Polymer Grate Only	84839	246mm	246mm	20mm
Flo-way™ / Rainwater Sandstone Polymer Grate Only	84818	246mm	246mm	20mm
Flo-way™ / Rainwater Grey Polymer Grate Only	84830	246mm	246mm	20mm
Flo-way™ / Rainwater Aluminium Grate Only	21330	248mm	248mm	20mm
Flo-way™ / Rainwater EURODESIGN Stainless Steel Grate Only	97844	248mm	248mm	20mm
Flo-way™ / Rainwater EURODESIGN Stainless Steel A/V Grate Only	97845	248mm	248mm	20mm

NOTE: All EURODESIGN grates are made from 316 Stainless Steel and are heel friendly. A/V refers to Anti-Vandal

For complete warranty information or standards applicable to any of our products, please contact 13 19 26 or email info@everhard.com.au. Visit everhard.com.au for the latest product updates, news and releases.

All measurements throughout this brochure are in millimetres and are solely for reference purposes. Any changes resulting from technical advance of design may be made without prior notice. Always refer to the physical product and instructions before installing. While every care has been exercised in compiling and publishing the information contained in these pages, Everhard accepts no responsibility for errors or omissions and all information is believed to be correct at the time of printing. Everhard reserves the right to delete or alter items without notice. Appliances are for display purposes only. Colours have been reproduced with as much accuracy as possible. Styles, sizes and colours may vary.

BRANCHES

Head Office
405 Newman Road
Geebung QLD 4034
(07) 3637 6444

Cairns
55 Supply Road
Bentley Park QLD 4869
(07) 4031 3558

Sydney
464 Victoria Street
Wetherill Park NSW 2164
(02) 8711 1111

Melbourne
11-13 Claredale Road
Dandenong VIC 3175
(03) 9771 7344

Perth
28 Haydock Street
Forrestdale WA 6112
(08) 9417 8222

AGENTS

Wholesale Products
2B Knoll Street
Glenorchy TAS 7010
(03) 6273 3455

Young's Distribution Centre
8 Whitehouse Street
Garbutt QLD 4814
(07) 4779 0222

Tradeware Group SA
45 Birralee Road
Regency Park SA 5010
(08) 8244 0344

Tradeware Group NT
2/28 Toupein Road
Yarrowonga NT 0830
(08) 8931 1228



ESTABLISHED
1926